



D3.1 - Regulatory and Standardization State of the Art

<i>Project contract n:</i>	101135417 — STAN4SWAP — HORIZON-CL4-2023-HUMAN-01	
<i>Workpackage, WP title</i>	WP3	
<i>Deliverable nr:</i>	D3.1	
<i>Deliverable title:</i>	Regulatory and Standardization State of the Art	
<i>Deliverable type:</i>	PU	
<i>Document preparation date:</i>	2024-06-30	
<i>Author</i>	P. Van den Bossche	VUB
<i>Co-authors</i>	B. Gindroz	BMGI
	K. Glennung	CENELEC

Consortium:

PIAGGIO & C. SPA, FRAUNHOFER GESELLSCHAFT ZUR FORDERUNG DER ANGEWANDTEN FORSCHUNG EV, HYBA SRL, COMITE EUROPEEN DE NORMALISATION ELECTROTECHNIQUE, VRIJE UNIVERSITEIT BRUSSEL, KTM FORSCHUNGS & ENTWICKLUNGS GMBH, SWOBEE GMBH, BMGI CONSULTING



Revision history.....	3
Executive summary	5
1. Legal & Regulatory state of the art.....	6
1.1 Introduction.....	6
1.2 General EU context	7
1.2.1 The Green Deal and Fit for 55.....	7
1.2.2 Legal Framework	7
1.2.3 Regulatory Framework	8
1.3 Towards Single Market 2.0	8
1.4 Mobility -- Transport -- Automotive (industrial ecosystem 10)	9
1.5 Main directives and regulatory references in the framework of STAN4SWAP project.....	9
1.5.1 Battery Regulation.....	10
1.5.2 Alternative Fuels Infrastructure Regulation.....	10
1.5.3 Radio Equipment Directive	10
1.5.4 Low Voltage Directive.....	11
2. Standardization state of the art.....	12
2.1 Standardization actors.....	12
2.2 Battery swap standards: IEC62840	12
2.2.1 Introduction	12
2.2.2 IEC62840-1.....	12
2.2.3 IEC62840-2.....	13
2.2.4 IEC62840-3.....	13
2.3 Accessory standards	14
2.3.1 IEC/TS 62196-4.....	14
2.3.2 IEC 63066.....	15
2.4 Battery safety standards	16
2.4.1 Introduction	16
2.4.2 Traction battery cell safety: IEC62660	16
2.4.3 Portable battery cell safety: IEC62133-2.....	17
2.4.4 LEV battery systems: EN50604	18
2.4.5 Industrial batteries: IEC62619.....	19
2.5 Battery chargers	20
3. Standardization Requests in relation with swappable battery systems	21
4. Conclusions	21
References.....	22
Acknowledgements	24



Revision history

Deliverable title: D3.1 – Regulatory and Standardization State of the Art

Filename: STAN4SWAP_D3.1_Regulatory and Standardization State of the Art_V1.0

Version	Date	Action	Partner
V1.0	2024-06-30	First released version submitted on the EC Portal	PIAGGIO
V1.1	2025-02-18	Updated following midterm evaluation	CENELEC-VUB



List of acronyms

AFI-R	Alternative fuels infrastructure regulation
BATT-R	Battery regulation
BMS	Battery management system
CD	Committee draft
CDV	Committee draft for voting
EC	European commission
EN	European standard
ESO	European standardization organization
EV	Electric vehicle
EVSE	Electric vehicle supply equipment
FDIS	Final Draft International Standard
GHG	Greenhouse gas
HDV	Heavy duty vehicle
IEC	International Electrotechnical Commission
IS	International standard
ISO	International Organization for Standardization
JRC	Joint research centre
JWG	Joint working group
LEV	Light electric vehicle
LVD	Low voltage directive
NP	New work item proposal
PAS	Publicly available specification
RBS	Removable battery system
RED	Radio equipment directive
RESS	Rechargeable energy storage system
SBS	Swappable battery system
SC	Sub-committee
TC	Technical committee
TR	Technical report
TS	Technical specification
WG	Working group



Executive summary

WP3's aim is to map the legal and regulatory context of the EU, existing standards and initiatives relevant to the exchange system (at EU and global levels). This includes existing standardization requests to support regulations. This will enable the STAN4SWAP project to identify its priority areas of action. The three subtasks of WP3 together provide a comprehensive road map for regulatory and standardized landscapes surrounding switchable battery systems, clearly identifying areas of action to be taken for "needs and gaps" (e.g. WP 6, 7).

Task 3.1 Legal & Regulatory state of the art

In this task, the legal and regulatory framework for the European Union will be examined and mapped. In addition to general regulatory documents such as EU directives, such as LVD, there may be an opportunity for specific national regulations to be considered. This task will foremostly identify the legal hurdles which may exist in the EU or in individual countries and which may interfere with the deployment of swappable battery systems.

Task 3.2 Standardization state of the art

The aim of this task is to map various international and regional standards defining specifications for safety, compatibility and performance aspects of replaceable battery systems. Most of this standardization work on electrotechnology topics is carried out by the IEC at a global level, and CENELEC adopts international standards as European standards, and drafts specific European standards where appropriate.

Task 3.3 Standardization Requests in relation with swappable battery systems

This task will identify the various Standardization Requests issued by the European Commission to CEN and CENELEC, where there are requests of deliverables to be developed on the topic of battery swapping for vehicle.



1. Legal & Regulatory state of the art

1.1 Introduction

One of the main goals of the 2020 updated industrial strategy is to support a stronger Single Market for Europe's recovery. This goal will be met thanks to enhanced global leadership in technologies and leadership in standard-setting towards ensuring interoperability across the EU industrial ecosystems.

Standards are key enablers of the EU green transition, which means that it is of highest importance for Europe to set all conditions for global leadership as a matter for the competitiveness and resilience of EU industries. European Standardization Organizations – ESOs - support and promote the convergence of standardization work/development towards alignment at global level, which contributes to a reduction of adaptation costs and to strengthen EU and global value chains, however with ensuring EU priorities be considered.

Standards and standardization are recognized as a major tool for promoting innovation, both for policymakers and businesses. Standardization is an important factor for valorizing EU R&I projects, thanks to allowing new technologies to enter into a more mature phase, favoring their applicability on a larger scale and hence promoting their uptake; in a word boosting innovation to market.

Bringing the research and innovation community together with industrial stakeholders early on into the standards-making process is key to identify the issues and priorities, share views on future developments and stakeholder/users' needs, and to provide recommendations to the European Commission and European Standardization Organizations for future standardization needs.

The aim of this chapter is to concentrate on the legal and regulatory context in the European Union, in support of meeting its commitments, and especially in the framework of decarbonized mobility.



Figure 1: EU Green deal objectives



1.2 General EU context

1.2.1 The Green Deal and Fit for 55

Following the climate targets set in the Paris Agreement, the European Union aims to make Europe the first climate-neutral continent by 2050. By end of 2019, the EU established the European Green Deal, with a initial set of targets to be met by 2030. With its ultimate goal of reaching climate neutrality by 2050, the EU Green Deal sets the EU on the path to a green transition. It aims at transforming the European Union into a fair and prosperous society with a modern and competitive economy.

In July 2021, the European Commission adopted the Fit for 55 package, a broad legislative package to align existing EU policy with the new emissions reduction goal of 55% by 2030, supporting the implementation of the Green Deal. The package aims to make the EU “fit for 55” and deliver the transformational change needed in a way that is fair, cost-efficient and competitive. The primary objectives of the package are given in fig. 2.

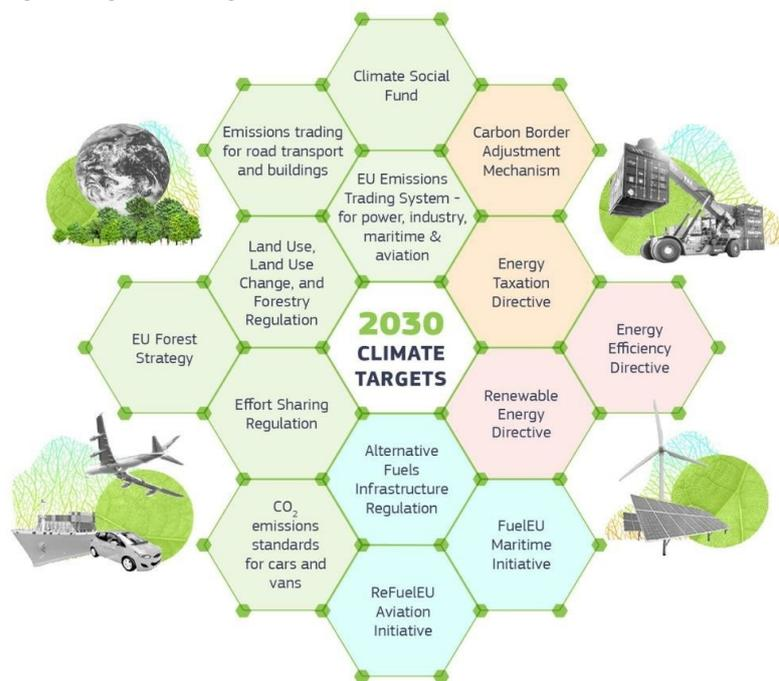

Figure 2: Fit for 55 — legislative package

1.2.2 Legal Framework

A predictable pathway for the ecosystem has been set by the Sustainable and Smart Mobility Strategy. This includes major legislative adaptations and evolutions, such as Euro7, CO2 standards, FuelEU Maritime, FuelEU Aviation, Rail Freight Corridors regulation, Combined Transport and batteries regulation. This ecosystem will face huge investments both in legacy and green technologies, where standardization could definitely be of major support, by boosting innovation to market(s) as well as creating trust and confidence.

This massive shift to clean mobility offers opportunities for EU to become a global leader in decarbonizing the sector.



1.2.3 Regulatory Framework

A predictable pathway for the ecosystem has been set by the Sustainable and Smart Mobility Strategy. This includes major legislative adaptations and evolutions, such as Euro7, CO2 standards, FuelEU Maritime, FuelEU Aviation, Rail Freight Corridors regulation, Combined Transport and batteries regulation.

1.3 Towards Single Market 2.0

The European Green Deal brought major opportunities to transform the EU's Single Market for the net-zero age. The first Annual Single Market Report [1] identifies 14 industrial ecosystems shown in fig. 3.

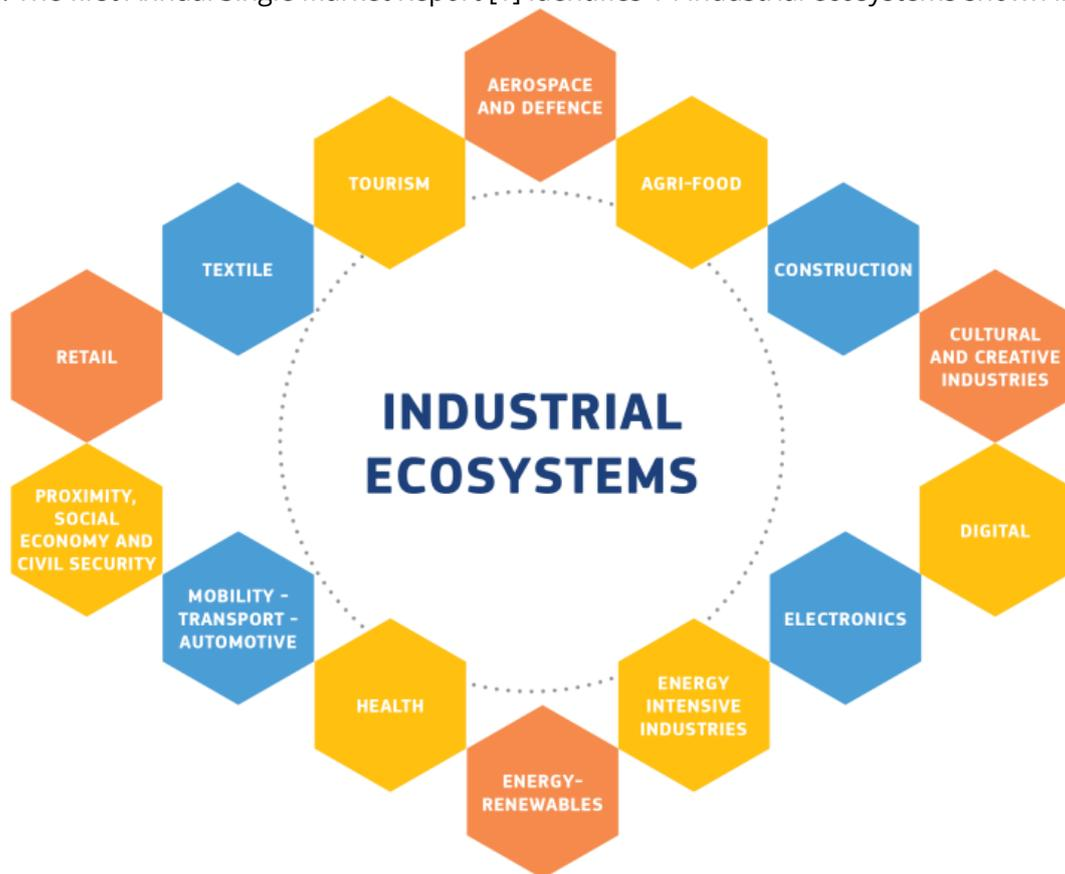

Figure 3: The 14 industrial ecosystems of the European Single Market

Source: European industrial strategy (europa.eu)

The joint initiative "Putting standards into science" developed by CEN-CENELEC and the Joint Research Centre (JRC) has shown its relevance as an important initiative to anticipate and prepare the standards-development process in future areas. Needs and challenges are analyzed, underlying the relevance of standardization in each ecosystem and proposing specific actions to overcome existing barriers in the in the Single Market.



1.4 Mobility -- Transport -- Automotive (industrial ecosystem 10)

Transport is a fundamental sector for and of the economy. The sector represents about 1.2 million private and public companies in the EU, and 11 million jobs, providing goods and services, and mobility. From the first Annual Single Market Report [1] mentioned in the previous chapter, the sector has been identified as Industrial ecosystem number 10.

Emissions in the heavy-duty vehicles (HDV) sector have been steadily increasing since 2014. Trucks, city buses, and long-distance buses are responsible for over 6% of total EU greenhouse gas (GHG) emissions and more than 25% of GHG emissions from road transport. The EU Green Deal objectives are calling for European transport operators and users to support deployment of more energy-efficient vehicles.

Electric Vehicles (EV) play an important role in transportation to support the decarbonization of transport industry. However, one of the main barriers to its widespread adoption is the need to recharge the battery which makes it inconvenient especially with limited charging capacities. This is especially true for EV making long distance, but also for Light categories (L-cat) e-vehicles — 2 wheelers, 3-4 wheelers light vehicles — with limited energy capacities. Battery swapping is a new system that offers an attractive alternative which allows electric vehicle (EV) owners to swap out their empty batteries for fully charged ones in a matter of minutes. This innovation has the potential to revolutionize the EV industry, and, especially, L-cat e-vehicles deployment.

When identifying needs expressed by cities and citizen about mobility, the issue about decarbonization, decongestion (traffic), noise reduction and reduction of space occupation by vehicles are among the priorities. In this context, electrical L-cat vehicles – two wheelers and light 3-4 wheelers for passengers and good – represent a impactful solution to urban decarbonization and decongestion challenges. This confirms ISO/ TC 268 'Sustainable cities and communities' collected inputs where a preference for L-categories vehicles instead of individual cars has been identified, in addition to electrification of the sector.

However, while traditional light e-mobility vehicles with individual batteries and needs for plugging charging plots do not bring sufficient and sustainable solutions to e-mobility strategies especially in urban areas, swappable batteries system offers a new efficient solution, with energy related support to renewables electricity supply system, and, in addition, a relevant approach towards efficient energy management, follow-up of batteries state of health, decision towards secondary life up to end of life of the equipment and recycling.

Such solutions, contributing in a significant manner to decarbonizing the mobility sector, especially in urban areas, will bring significant impacts towards meeting the EU carbon neutrality targets, through standardized battery packs that will support interoperability for a large range of vehicles brands and models (from different OEMs), as well as standardized specs towards compatibility and data collection, storage and usages for fulfilling our EU electrical mobility related regulatory framework.

1.5 Main directives and regulatory references in the framework of STAN4SWAP project

As a full part of the Fit for 55 legislative package, the following pieces of legislation are considered in STAN4SWAP as of direct and essential concern in the development of Swappable Batteries for Light categories of vehicles:



- Battery Regulation - Batt-R – (Regulation (EU) 2023/1542) [2]
- Alternative Fuels Infrastructure Regulation - AFI-R – (Regulation (EU) 2023/1804) [3]
- Radio Equipment Directive – RED – (2014/53/EU) [4]
- Low Voltage Directive – LVD - (2014/35/EU) [5]

1.5.1 Battery Regulation

The New Battery Regulation (EU) 2023/1542 [2] was published on July 28, 2023, with an entry into force from August 17, 2023.

This regulation has the following objectives:

- strengthening the functioning of EU internal market: products, processes, waste batteries and recycling
- promoting a circular economy
- reducing environmental and social impacts during the entire battery life cycle

This regulation specifies mandatory requirements for all batteries placed on the EU market¹. Those requirements cover sustainability and safety, labelling, marking and information, due diligence, waste battery management, battery passport, green public procurement.

The regulation sets the obligations of the manufacturer, the importer and distributor of batteries, and of all products containing batteries. The regulation also establishes conformity assessment procedure and market surveillance requirements.

STAN4SWAP considering swappable batteries in the mobility sector for L-cat of vehicles, this Battery Regulation is of primary importance.

1.5.2 Alternative Fuels Infrastructure Regulation

The New Alternative Fuels Regulation (EU) 2023/1804 [3] was published at the end of September, 2023, with an entry into force from April 13, 2024. This regulation is repealing Directive 2014/94/EU [6]. The objectives of the Alternative Fuels Infrastructure Regulation (2023/1804) is to push for the widespread availability of charging and refueling stations for alternative fuels, catering to different types of vehicles all over Europe.

The AFIR sets binding national targets for the development of EU alternative fuel infrastructure. It also establishes common technical specifications and requirements regarding the information to vehicle users for the provision of data and payment requirements. The AFIR includes detailed regulations regarding light- and heavy- electric vehicles as well as planes and ships. Electrical charging systems are a full part of the regulation, and, thus, of primary interest for STAN4SWAP in the context of swappable batteries in the mobility sector and L-cat vehicles.

1.5.3 Radio Equipment Directive

The Radio Equipment Directive (RED, EU directive 2014/53/EU) [4] established a regulatory framework for placing radio equipment on the market in the EU. All radio equipment within the scope of this directive that are placed on the EU market must have been compliant with the directive from 13 June 2017.

The Commission adopted a Delegated Act of the Radio Equipment Directive activating Articles 3(3)(d), (e) and (f) for certain categories of radio equipment to increase the level of cybersecurity, personal data

¹ Military, space and nuclear applications are excluded



protection and privacy. Originally scheduled for enforcement in August 2024, the delegated act of Radio Equipment Directive (RED) has been postponed to 2025 due to ongoing preparation of harmonized standards. Consequently, all wireless devices and products sold in the European Union (EU) will be required to comply with the RED delegated act from August 1, 2025.

Wireless communication will be a full part of the battery-Regulation, as, for instance, requiring information about the battery (i.e. state of health, state of charge) to be accessible by users, this Directive (esp. new delegate act) will be considered in STAN4SWAP in the context of swappable batteries in the mobility sector and L-cat vehicles.

1.5.4 Low Voltage Directive

The low voltage directive (LVD) (2014/35/EU) [5] ensures that electrical equipment within certain voltage limits provides a high level of protection for European citizens, and benefits fully from the single market. It has been applicable since 20 April 2016.

The LVD covers health and safety risks on electrical equipment operating with an input or output voltage of between:

- 50 and 1000 V for alternating current
- 75 and 1500 V for direct current

STAN4SWAP is considering in priority mobility application for L-cat vehicles that, a priori, do not fall under the definition of the LVD; However, this regulation is a full part of the pieces of legislation STAN4SWAP will refer to.



2. Standardization state of the art

2.1 Standardization actors

In urban traffic, due to their beneficial effect on environment, electric vehicles are an important factor for improvement of traffic and more particularly for a healthier living environment. Electric vehicles need an appropriate charging infrastructure for their energy supply, and this infrastructure needs international standards to allow safety and interoperability. The standardization work is mainly done within IEC regarding the infrastructure issues, with specific vehicle-based aspects covered by ISO.

This division of labour between the two organizations has not always been straightforward. International standardization for electric vehicles started already in the 1970s, with both IEC and ISO trying to cover the whole subject. Collaboration was sometimes not very smooth, also due to the different standardization culture in the electrotechnical sector versus the automotive sector, and the different background of experts seating in the respective committees.

By the end of the 1990s, the division of labour was made clear, with ISO (TC22 SC21, later SC37) covering the vehicle-related aspects and IEC (TC69) covering electrical aspects including charging infrastructure. IEC TC69 is thus the main committee dealing with charging infrastructure standards.

The light electric vehicles with swappable batteries considered by the STAN4SWAP project cover various technology realms and several other committees might be involved, such as IEC SC23H for accessories, IEC TC21 and SC21A for batteries or IEC TC61 for household appliances.

2.2 Battery swap standards: IEC62840

2.2.1 Introduction

The subject of swappable batteries was first proposed to IEC TC69 in 2012-13, with new work item proposals presented by the Chinese and Israeli national committees. These have led to the IEC62840 family of standards, the only ones specifically devoted to battery swap systems. IEC62840-1 “Electric vehicle battery swap system - Part 1: General and guidance” was published as Technical Specification in 2016 [7] and its development to International Standard level is now at CDV stage [8]. Part 2 on Safety requirements was published as IS in 2016 [9], its revision is now at CDV level [10].

The third part, dealing with particular safety and interoperability requirements for battery swap systems operating with removable RESS/battery systems was published as PAS [11].

2.2.2 IEC62840-1

The first part gives a general overview of battery exchange systems for electrical road vehicle batteries, introducing system concepts and use cases.

It marks the difference between “swappable” and “removable” battery systems, describing typical system components for both. The swappable battery system, where the batteries are moved by the charging station handling system, is foremostly aimed at larger vehicles (cars and heavy duty vehicles), whilas the removable system aims at lighter vehicles. An example of removable battery system is given in fig. 4.



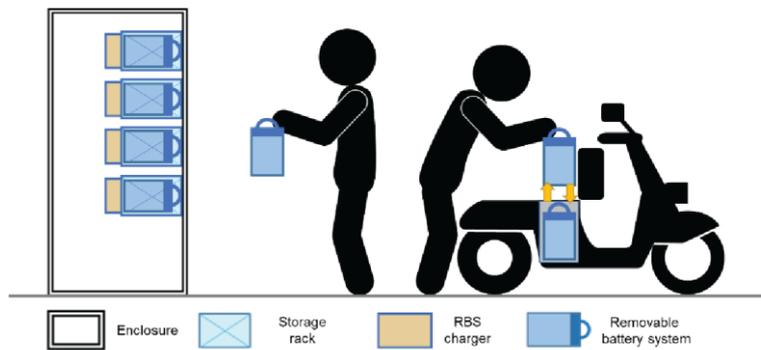

Figure 4: Manual swapping station layout [8] ©IEC

The document also presents typical use cases in annex. Use cases for removable battery systems, taken from part 3 (section 2.2.4 below) were present in the CD version [12] but were not withheld however the most recent CDV. [8], because “there is in the working group no expert who can support and explain this annex”, as stated in the comments on the CD [13].

2.2.3 IEC62840-2

The second part, published as IS in 2016 [9], is now being revised at CDV level [10]. It contains the general safety requirements for swappable or removable battery systems. The battery swap system shall be so designed and constructed that in normal use its performance is reliable and minimizes the risk of danger to the human individuals, equipment and surroundings. Reference is made to general safety standards for electric machinery and robotic devices such as IEC 60204 [14], IEC61511 [15], ISO13849 [16] and ISO10218 [17]. Specific additional aspects related to the application are covered including the operational safety of the vehicle lane system, the battery handling and storage systems, removable/swappable batteries and chargers. Special attention is given to electrical safety requirements.

2.2.4 IEC62840-3

Development

The third part of IEC 62840 [11], dealing with particular safety and interoperability requirements for battery swap systems operating with removable RESS/battery systems, has had a checkered history. Initially, this document was intended to be part of the IEC61851-3 series. IEC61851-3's original scope was the conductive charging of “light electric vehicles” (LEV). The exact definition of LEV proved however to be difficult, as it depended on varying national regulations taking into account factors like weight, number of wheels, maximum speed,... which are hardly related to the electrical safety aspects of the charging process which were the real scope of the standard. For this reason, the documents of the 61851-3 series refer to “DC EV supply equipment where protection relies on double or reinforced insulation” which is in fact the protection method most widely used for LEV. Such “Class II” equipment shall not be earthed. The various parts of IEC61851-3 were eventually published as Technical Specification in 2023. The third part 61851-3-3 however, dealing with removable battery systems, was taken out of the series and transferred to the 62840 project. It was decided to publish the document as a PAS based on the TS 61851-3-3 draft, as an intermediate standard that meets specific market, which has been published prior to the development of a complete international standard. As such, IEC PAS 62840-3 is still heavily indebted to 61851-3-1 [18]. With the future revision of IEC 62840 all components, IEC PAS 62840-3 will be fully integrated into the IEC 62840 series.



Use cases

The document describes a number of use cases with increasing degree of automation, the mandatory and optional functions of which are given in table 1.

Table 1: Use case subsystems [11] ©IEC

Sub-system	Storage system		Handling system		Lane system
Function	storage	power transfer	mounting/ un-mounting	transfer	
Use case					
convenience store device (attended)	M	M	n.a.	n.a.	n.a.
unattended locking compartment DC	M	M	n.a.	n.a.	n.a.
battery exchange box	M	M	n.a.	n.a.	O
automatic battery exchange box	M	M	M	M	M
automatic vehicle storage system	M	M	M	M	M

New developments

A NP to upgrade 62840-3 from PAS to TS status was circulated in June 2024 [19].

It provides specific requirements for battery swap systems operating with removable battery systems of electric road vehicles, whose rated voltage is less than 120V DC. It specifically applies to battery swap systems intended for supplying removable battery systems for light electric vehicles with less than four wheels (Category L [20]), and tricycles and electrically pedal assisted cycle (according to EN15194 [21]).

The draft coming with this NP is still a very preliminary and incomplete document. It severs the link with 61851-3 series, stating specific requirements instead. Also, it does not mention the use cases from table 1; further evolution of this document is expected however when it will circulate as CD and beyond.

2.3 Accessory standards

Accessories to be used with the considered systems are covered by documents developed by IEC SC23H, of which two documents are particularly interesting for this project:

2.3.1 IEC/TS 62196-4

IEC62196 is the family of standards covering plugs, socket-outlets, vehicle connectors and vehicle inlets for conductive charging of electric vehicles. The fourth part in the series, published as TS in 2022 [22],



covers the dimensional compatibility and interchangeability requirements for DC pin and contact-tube accessories for Class II or Class III applications.

Class II and III refer to the measures taken to protect against electric shock: double or reinforced insulation for Class II and extra-low voltage for class III.

2.3.2 IEC 63066

This document, published as TS in 2017 [23], covers low-voltage docking connectors for removable energy storage units. It is under revision for publication as IS in 2025. Comments in this section are based on the latest CD [24].

Pluggable energy storage technology has a large demand and perspective in certain areas. With the advent of electric vehicles, energy storage units for renewable energy and other applications, guidance is needed to ensure safe and reliable operation, interoperability, environmental protection and energy efficiency. The industry needs such a standard to promote the technology development and popularization of pluggable energy storage technology.

In comparison to other accessories, certain specific items are taken into account. The operator might not have tactile feedback during the mating process to correctly align the two parts of the connector. Additionally, a mechanical feed in the mating process might prevent proper alignment of the connector parts. To address these challenges, the accessory design may include movable components to compensate for mechanical feed and tolerances.

IEC63066 applies to docking connectors incorporated in or fixed to electrical equipment, intended to connect removable energy storage units to a dedicated electric power conversion unit, to an energy consuming unit or to another energy storage unit. These accessories are intended for DC. A typical layout is given in fig. 5. In this figure, A and B are docking connectors, C the removable battery, D the rack and E guiding means.

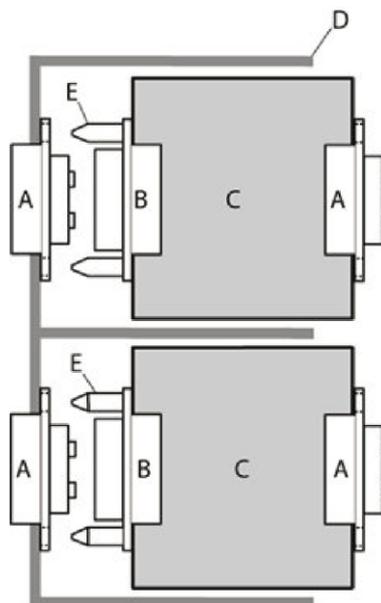

Figure 5: Use of accessories [23] ©IEC

Requirements are given for electrical and mechanical properties of the accessories; these requirements are largely based on IEC60309-1 [25] – the general standard for industrial plugs and connectors – amended where necessary for the specific needs of docking connectors.



The document defines three types of accessories in standard sheets, among them a docking connector rated 60V, 50A for battery swap systems under IEC/PAS 62840-3 .

Furthermore, it gives some examples of similar accessories, without however presenting these as standard sheets, which may happen in next edition.

2.4 Battery safety standards

2.4.1 Introduction

As for standardization of batteries, several committees have started activities following the advent of lithium batteries in the early 2000s. As to avoid double use and overlapping or conflicting standards, high level resolution was needed, with the following division of labour resulting:

- ISO TC22 SC37 dealing with lithium traction battery systems for electric vehicles
- IEC TC21 (in JWG with IEC TC69) dealing with lithium battery cells and modules for electric vehicle applications
- IEC SC21A dealing with stationary and non-automotive lithium batteries

Battery safety standards come in two ways, they can be either cell-oriented or system-oriented. The cell standards usually emanate from IEC (TC21 or SC21A), whereas the system standards are drafted by ISO or CEN, with their TCs covering the vehicles.

2.4.2 Traction battery cell safety: IEC62660

Parts 2 [26] and 3 [27] of IEC62660 "Secondary batteries for the propulsion of electric road vehicles" deal respectively with safety testing and safety requirements for battery cells and modules. The tests in part 2 include mechanical (vibration, shock, crush – fig. 6), thermal and electrical (short circuit, overcharge, overdischarge) tests, whereas the requirements in part 3 state that the cells shall exhibit no evidence of leakage, venting, rupture, fire or explosion.

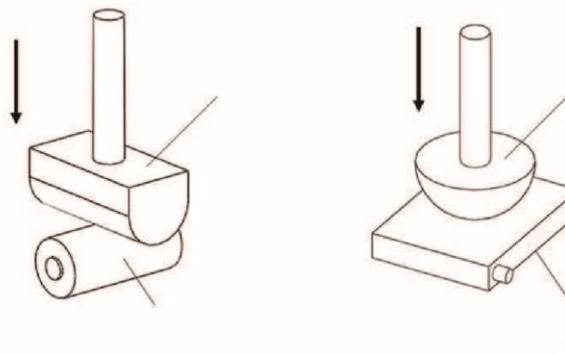

Figure 6: Example of crush test [26] ©IEC

Although these standards primarily aim larger vehicle batteries, cells covered by this standard are also likely to be used in LEV applications, albeit in smaller systems than for heavier vehicles.



2.4.3 Portable battery cell safety: IEC62133-2

This standard drafted by IEC SC21A and published in 2017 [28] and now under revision [29] specifies requirements and tests for the safe operation of portable sealed secondary lithium cells and batteries. It considers both intended use and reasonably foreseeable misuse, the latter defined as use in a way which is not intended by the supplier, but which may result from readily predictable human behaviour, such as external short circuit, free fall, crush, thermal abuse and abnormal charging or discharging. The cell design is evaluated through internal short circuit tests (caused by introducing a nickel particle in the cell (fig. 7)).

The safe operating regions for lithium batteries are also described (fig. 8).

Informative annexes to the document give recommendations for the design and use of batteries and equipment.

This standard covers a wide array of cell types and sizes, some of which may be applicable for LEV battery assemblies.

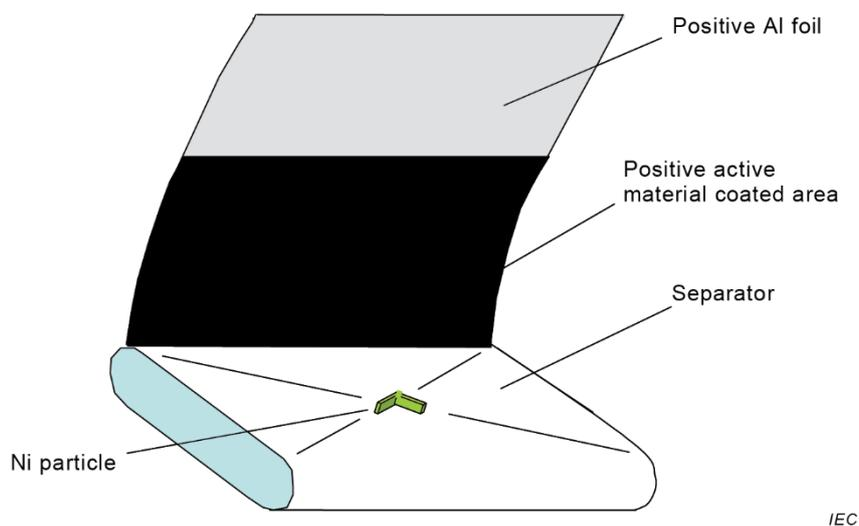

Figure 7: Internal short circuit test [28] ©IEC



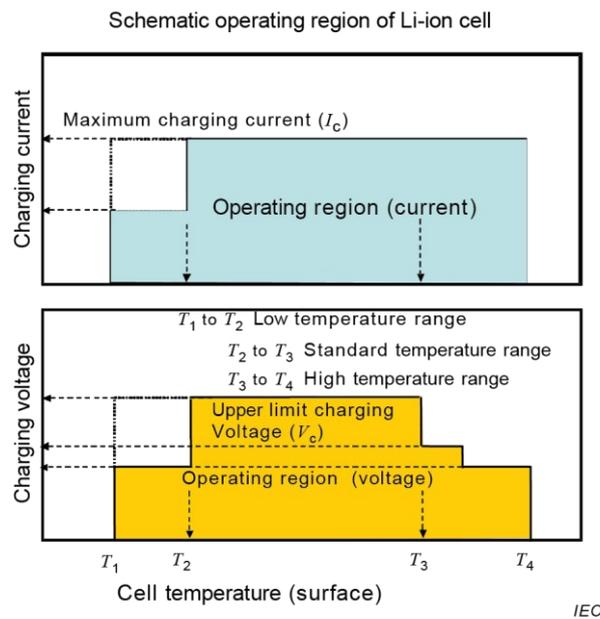

Figure 8: Charging operating range [28] ©IEC

2.4.4 LEV battery systems: EN50604

For light electric vehicles (including all electrically propelled vehicles of category L1 up to category L7, and all electrically propelled or assisted cycles including plug-in hybrids, that derive all or part of their energy from on-board RESS), a specific European standard was developed.

EN50604 "Secondary lithium batteries for light EV (electric vehicle) applications — Part 1: General safety requirements and test methods" was published in 2016 [30] and amended in 2021 [31].

It specifies test procedures and provides acceptable safety requirements for voltage class A and B (i.e. below or above 60V DC) removable lithium-ion battery packs and systems, to be used as traction batteries of or for electrically propelled road vehicles.

The reference to systems described in the IEC61851-3 series was dropped in the 2021 amendment.

The standard is primarily system-oriented —excluding individual cells — and is thus to be considered in conjunction with the ISO standard 12405-3 [32] on EV lithium battery safety for electric road vehicle traction batteries. This standard has since been withdrawn however, superseded by ISO6469-1 [33]. This revised 6469-1 integrated its former edition with 12405-3 to become the main standard for EV battery safety, defining mechanical and electrical requirements and tests.

The next edition of EN50604 shall reflect this change in ISO standards.

The battery system fig. 9 encompasses battery pack (44) with cells (46), battery management system (43) and other ancillaries.



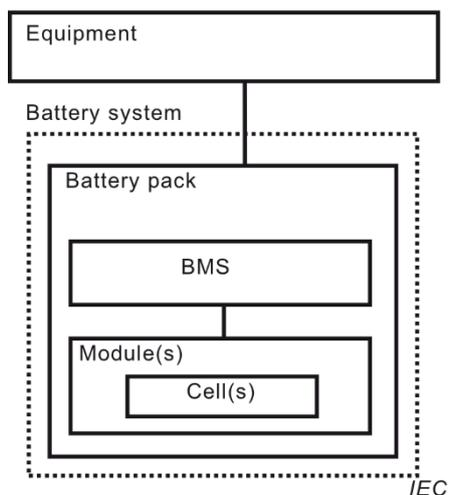

Figure 10: Battery management system [35] ©IEC

2.5 Battery chargers

Battery chargers for light electric vehicles often are considered akin to household appliances and ruled by corresponding standards such as IEC60335-2-29 [36] and IEC60335-1 [37]. These documents also serve as basis for IEC/TS61851-3-2 [38], which supplements or modifies the 60335 requirements and tests for mechanical and electrical safety.



3. Standardization Requests in relation with swappable battery systems

There is only one active standardization request to CEN and CENELEC where there are requests of deliverables on the topic of battery swapping: the M/581 [39] (AFI II). In this standardization request, the EC asks CEN and CENELEC to develop 4 deliverables on this topic:

- A European standard containing technical specifications with a unified solution for battery swapping for heavy duty vehicles
- A European standard containing technical specifications with a unified solution for battery swapping for L category vehicles
- A European standard containing technical specifications with a unified solution for battery swapping and recharging at onshore stations for inland waterways vessels
- A European standardisation deliverable on battery swapping for electric vehicles

4. Conclusions

As for the development of international standards relating to battery swap systems for LEV, the current state of the art is quite limited with only the 62840-3 project directly related to the theme. As this document is currently under revision, it is typically one issue where STAN4SWAP project expertise could bring a contribution to the development of standards, taking into account that such contribution shall be done through IEC NCs. As the leadership of the working group WG13 in IEC TC69 is now based in China, the opportunity to add European viewpoints could be interesting.

Other standards on batteries, accessories, ...could also prove interesting for the needs of the project.



References

- [1] European commission, COMMISSION STAFF WORKING DOCUMENT Annual Single Market Report 2021 Accompanying the Communication from the Commission to the European Parliament, the Council, the European Economic and Social Committee and the Committee of the Regions Updating the 2020 New Industrial Strategy: Building a stronger Single Market for Europe's recovery. SWD/2021/351, 2021.
- [2] European Union, Regulation (EU) 2023/1542 of the European Parliament and of the Council of 12 July 2023 concerning batteries and waste batteries, amending Directive 2008/98/EC and Regulation (EU) 2019/1020 and repealing Directive 2006/66/EC. OJ L191, 2023-07-28, 2023.
- [3] —, Regulation (EU) 2023/1804 of the European Parliament and of the Council of 13 September 2023 on the deployment of alternative fuels infrastructure, and repealing Directive 2014/94/EU. OJ L234, 2023-09-22, 2014.
- [4] —, Directive 2014/53/EU of the European Parliament and of the Council of 16 April 2014 on the harmonisation of the laws of the Member States relating to the making available on the market of radio equipment and repealing Directive 1999/5/EC. OJ L153, 2014-05-22, 2014.
- [5] —, Directive 2014/35/EU of the European Parliament and of the Council of 26 February 2014 on the harmonisation of the laws of the Member States relating to the making available on the market of electrical equipment designed for use within certain voltage limits. OJ L96, 2014-03-29, 2014.
- [6] —, Directive 2014/94/EU of the European Parliament and of the Council on the deployment of alternative fuels infrastructure. OJ L307, 2014-10-28, 2014, vol. 57, no. L307.
- [7] IEC/TS62840-1, Electric vehicle battery swap system - Part 1: General and guidance, IEC Technical Specification 62840-1, 2016.
- [8] IEC62840-1/CDV, Electric vehicle battery swap system - Part 1: General and guidance. IEC TC69 WG13, 05 2024, no. 69/955/CDV.
- [9] IEC62840-2, Electric vehicle battery swap system - Part 2: Safety requirements, IEC International Standard 62840-2, 2016.
- [10] IEC62840-2/CDV, Electric vehicle battery swap system - Part 2: Safety requirements. IEC TC69 WG13, 05 2024, no. 69/951/CDV.
- [11] IEC/PAS62840-3, Electric vehicle battery swap system - Part 2: Part 3: Particular safety and interoperability requirements for battery swap systems operating with removable RESS/battery systems, IEC Publicly available specification 62840-3, 2021.
- [12] IEC62840-1, Electric vehicle battery swap system - Part 1: General and guidance. IEC International Standard 62840-1.
- [13] IEC TC69 WG13, Comments on 69/905/CD. IEC TC69 WG13, 03 2024, no. 69/948/CC.
- [14] IEC60204-1, Safety of machinery – Electrical equipment of machines – Part 1: General requirements, IEC International Standard 60204-1, 2016.
- [15] IEC61511-1, Functional safety – Safety instrumented systems for the process industry sector – Part 1: Framework, definitions, system, hardware and application programming requirements, IEC International Standard 61511-1, 2016.
- [16] ISO13849-1, Safety of machinery – Safety-related parts of control systems – Part 1: General principles for design, ISO International Standard 13849-1, 2023.
- [17] ISO10218-1, Robots and robotic devices – Safety requirements for industrial robots – Part 1: Robots, ISO International Standard 10218-1, 2011.



- [18] IEC/TS61851-3-1, Electric vehicle conductive charging system — Part 3-1: DC EV supply equipment where protection relies on double or reinforced insulation — General rules and requirements for stationary equipment, IEC Technical Specification 61851-3-1, 2023.
- [19] IEC/TS62840-3/NP, Part 3: Specific requirements for battery swap systems operating with removable /battery systems. IEC TC69 WG13, 06 2024, no. 69/965/NP.
- [20] UNECE-RE3, Consolidated Resolution on the Construction of Vehicles (R.E.3), 3rd ed. United Nations Economic Commission for Europe, 2014.
- [21] EN15194:2017+A1:2023, Cycles – Electrically power assisted cycles – EPAC Bicycles, ISO European Standard 15194, 2023.
- [22] IEC/TS62196-4, Plugs, socket-outlets, vehicle connectors and vehicles inlet – Conductive charging of electric vehicles – Part 4: Dimensional compatibility and interchangeability requirements for DC pin and contact-tube accessories for class II or class III applications, IEC Technical Specification 62196-4, 2022.
- [23] IEC/TS63066, Low-voltage docking connectors for removable energy storage units, IEC Technical Specification 63066, 2017.
- [24] IEC63066/CD, Low-voltage docking connectors for removable energy storage units. IEC SC23H, 09 2023, no. 23H/541/CD.
- [25] IEC60309-1, Plugs, socket-outlets and plugs for industrial purposes — Part 1: General requirements, IEC International Standard 60309-1, 2021.
- [26] IEC62660-2, Secondary lithium-ion cells for the propulsion of electric road vehicles – Part 2: Reliability and abuse testing, IEC International Standard 62660-2, 2018.
- [27] IEC62660-3, Secondary lithium-ion cells for the propulsion of electric road vehicles Part 3: Safety requirements of cells and modules, IEC International Standard 62660-3, 2022.
- [28] IEC62133-2, Secondary cells and batteries containing alkaline or other non-acid electrolytes - Safety requirements for portable sealed secondary cells, and for batteries made from them, for use in portable applications — Part 2: Lithium systems, IEC International Standard 62133-2, 2017.
- [29] IEC62133-2/CD, Secondary cells and batteries containing alkaline or other non-acid electrolytes - Safety requirements for portable sealed secondary cells, and for batteries made from them, for use in portable applications — Part 2: Lithium systems. IEC TC21A, 10 2023, no. 21A/866/CD.
- [30] EN50604-1, Secondary lithium batteries for light EV (electric vehicle) applications — Part 1: General safety requirements and test methods, CENELEC European Standard 50604-1, 2016.
- [31] EN50604-1/A1, Secondary lithium batteries for light EV (electric vehicle) applications — Part 1: General safety requirements and test methods, CENELEC European Standard 50604-1, 2021.
- [32] ISO12405-3, Electrically propelled road vehicles — Test specification for lithium-ion traction battery packs and systems — Part 3: Safety performance requirements, ISO International Standard 12405-3, 2014.
- [33] ISO6469-1, Electrically propelled road vehicles – Safety specifications – Part 1: Rechargeable energy storage system (RESS), ISO International Standard 6469-1, 2019.
- [34] United Nations, Manual of Tests and Criteria, 7th ed. United Nations, 2019.
- [35] IEC62619, Secondary cells and batteries containing alkaline or other non-acid electrolytes – Safety requirements for secondary lithium cells and batteries, for use in industrial applications, IEC International Standard 62619, 2022.
- [36] IEC60335-2-29:2016+AMD1:2019, Household and similar electrical appliances – Safety – Part 2-29: Particular requirements for battery chargers, IEC International Standard 60335-2-29, 2019.
- [37] IEC60335-1, Household and similar electrical appliances – Safety – Part 1: General requirements, IEC International Standard 60335-1, 2020.



- [38] IEC/TS61851-3-2, Electric vehicle conductive charging system — Part 3-1: DC EV supply equipment where protection relies on double or reinforced insulation — Particular requirements for portable and mobile equipment, IEC Technical Specification 61851-3-2, 2023.
- [39] Standardization request M/581, COMMISSION IMPLEMENTING DECISION of 24.3.2022 on a standardisation request to the European standardisation organisations as regards communication exchange, electricity and hydrogen supply for road, maritime transport and inland navigation in support of Directive 2014/94/EU and its planned revision under the "Fit for 55" package. C(2022)1710, 2021.

Acknowledgements

The authors thank the International Electrotechnical Commission (IEC) for permission to reproduce Information from its International Standards. All such extracts are copyright of IEC, Geneva, Switzerland. All rights reserved. Further information on the IEC is available from www.iec.ch. IEC has no responsibility for the placement and context in which the extracts and contents are reproduced by the author, nor is IEC in any way responsible for the other content or accuracy therein.

Figures 4, 5, 6, 8, 10 and Table 1 ©IEC
Figure 9 © CENELEC



This project has received funding from the European Union's Horizon Europe research and innovation programme under grant agreement No. 101135417. Additionally, This Work has received funding from the Swiss State Secretariat for Education, Research and Innovation (SERI) for its Associate Partner. The content of this publication is the sole responsibility of the Consortium partners listed herein and does not necessarily represent the view of the European Commission or its services.